



A Guide to Epoxy Grouting Preparation, Mixing, Installation and Testing of Epoxy Grouts

This Guide covers the mixing and installation instructions relating to the following Epoxy Resin Grouts:

- » MasterFlow 400
- » MasterFlow 648 - Flowable
- » MasterFlow 648 - Fluid

Introduction

Epoxy Grouts are precision grouts, used to support and align critical equipment, transferring loads from the equipment baseplate to the foundation.

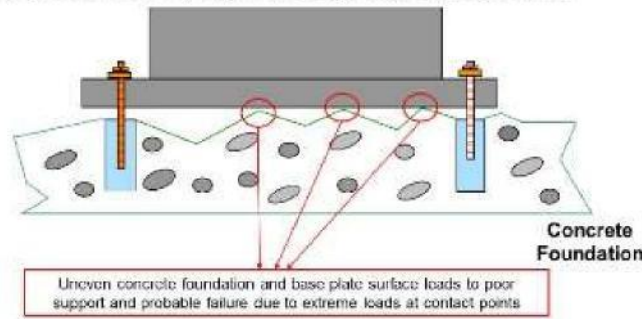

A precision grout must:

- Fill void between equipment base and foundation
- Maintain contact between surfaces
- Allow load/energy transfer from equipment to foundation

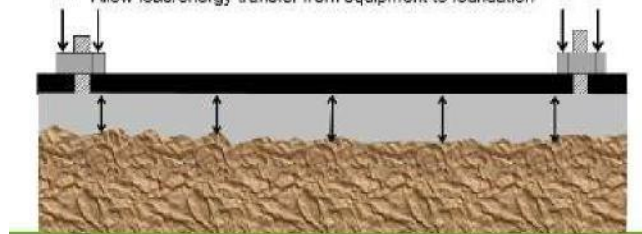

Grouting materials are selected based on the type of load they will support. Dynamic loads are associated with reciprocating equipment, motors, generators, turbines etc. Static loads are associated with columns or non-moving equipment.

Epoxy grouts offer unique performance advantages in many applications. They achieve strength quickly, allowing fast return to service or commissioning of equipment. Greater bond to the underside of a prepped baseplate, density and lower modulus of elasticity help to absorb impact and vibration. Low shrinkage and high tensile and flexural strengths optimize load transfer ensuring stable, secure alignment and protecting equipment from unnecessary wear and tear. Chemical resistance properties ensure they are durable even in harsh industrial environments.

With more than 100 years of experience in precision equipment grouting, Master Builders Solutions is an early developer and pioneer in both cementitious and epoxy grouts. We understand not only the in-service performance demands that our grouts must meet, but also the inter-relationship between various physical properties and application criteria that must be carefully considered. Master Builders Solutions has applied advanced chemistry to balance the physical properties of compressive strength, bearing area, chemical and high temperature resistance, shrinkage and creep with the sometimes difficult yet also very important application enablers of flow and working time, to provide uncompromised and durable support, protecting the

equipment investment by improving reliability, operating efficiency and life cycle of machinery.

The performance of any epoxy grout, in fact for most all construction materials, depends on the proper fit-for-purpose design, and the proper installation. This Guide to Epoxy Grouting is designed to help equipment manufacturers, engineers and specifiers, owners and contractors understand the Proper Preparation, Mixing, Installation & Testing of Epoxy Grouts to enable durable, quality, installations of MasterFlow Grouts.

Further information on the engineering properties, design protocols and testing methods related to epoxy grouting can be found on our website, or from any of our dedicated Master Builders Solutions technical experts across the globe.

<https://www.master-builders-solutions.com/en-sa/products/masterflow>

Proper Preparation, Mixing, Installation & Testing of Epoxy Grouts

Foundation Preparation

Before setting structural elements or machinery, all of the areas of the foundation which will be in contact with the grout, including anchor bolt holes, must be properly prepared. The concrete foundation surface must be thoroughly cured, and roughened as specified, to expose sound aggregate.

A fresh concrete surface may be uniformly roughened before it has set using a nail rake in one direction only. Use of a bull float, darby, broom, or wood float finish, or scratching at random with a garden rake or trowel is *NOT recommended*.

For hardened concrete foundations, hand held, pistol grip pneumatic hammers with chisel point heads are recommended for roughening to remove laitance and loose material. Use of large paving breakers equipped with bush hammers, spade or chisel bits, are *NOT recommended*. Where grout will extend horizontally out beyond the edge of the plate or object to be grouted, the foundation must also be prepared below these areas to help assure bond.

All laitance and unsound material must be removed, and the foundation must be free of oil, grease, wax, curing membranes and other contaminants. Surfaces should be clean and dry before application of the grout.

If an anchor bolt sleeve is to be filled, be sure all water is removed. Use a siphon, vacuum pump, or rubber hose and bulb. Remove the residual moisture by either forced air or evaporation. If the anchor bolt sleeve will not be grouted, seal the bolt hole with felt, foam rubber or other means. Cover all shims, anchor bolts and leveling screws to keep the grout from adhering. Use model clay, glazing putty or anything of a putty consistency which will stick but not harden, holding down bolts can be provided with a "foam rubber" sleeve to prevent adhesion and allow room for movement without imparting stresses on the surrounding grout.

Because the coefficient of thermal expansion of epoxy grout is higher than that of concrete or steel, grout that extends to the edge of a foundation that has a 90 ° edge can lift or tear the concrete just below that edge. Never place grout near the edge of a concrete foundation that has a 90 ° corner or edge. Chamfer the edge of the concrete 45 degrees to about a 2" (51 mm) width. Chamfering the foundation edge will spread the uplift load and reduce the potential for edge lifting.

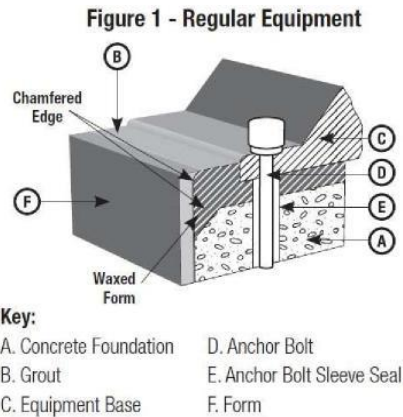

Protect the foundation and equipment from rain or moisture. Areas not to be grouted must be sealed off. Shade the foundation from summer sunlight for at least 24 hours before and 48 hours after grouting. Keeping the surface covered will make the later job of cleaning the surface prior to grouting much easier and less costly.

Plate and Equipment Preparation

The bonding surfaces of the base or plate to be grouted should be sandblasted to “white metal” and be free of coatings, wax, grease or scale. Other mechanical methods such as grinding, or sanding are also effective but do not produce as high a bond strength as sandblasting. However, where new plant and equipment have been surface finished with high quality coating systems (e.g. polyurethane), these need not be removed.

Primer should be used ONLY when a long delay between cleaning and grouting could allow excessive rusting or contamination. If the base must be primed, consult your local Master Builders Solutions sales representative for a primer recommendation. If the primer has been on the surface for more than one month, abrade and solvent wipe it so that no residue remains

Since the grout will come up at least 10–15 mm onto the equipment, it may be advisable to mask above this area with masking tape. To permit easy clean up, wax or cover all surfaces where the grout may splash.

Forming

Construction of forms and grouting should follow as soon as practical after erection and alignment of baseplates are completed. The forms should be compatible with (1) the placement method to be used, (2) consistency at which the grout will be placed, and (3) the distance the grout must travel. Forms should be built to facilitate continuous, quick and complete filling of the space with these factors in mind.

Forms must be liquid tight and strong enough to withstand the hydraulic pressure of the grout, without leaking. Materials used in building forms include wood (the most common), polystyrene, steel and on rare occasions such exotic material as plexiglass. Forming materials which are absorbent, such as wood, should be coated with wax, grease, or a plastic coating. These coatings act as bond breakers so that smooth grout surfaces result after form removal, and the forms are protected for reuse.

Seal wood forms to vertical concrete surfaces by applying putty or caulking below top of concrete, then press form into place. The points to caulk are the interfaces between the form and rough foundation surface where grout might leak out during its placement or before setting. Material used for caulking between the form and concrete surface may be joint sealants or epoxy mortars. Vertical joints in the forms should be caulked, especially if large cracks are evident. Caulking should be done on the outside edge of the form rather than the inside. The use of duct tape or “silver” tape applied on the inside of the form, at corners, is useful for this.

Grout is preferably placed from only one direction, so forms should include a placing side, exit side, and side forms, all of which direct and contain the grout under the object being grouted.

Forms should extend vertically a minimum of 1 inch (25 mm) or higher than the underside of the bedplate of the

equipment to help ensure complete filling of the space to be grouted and prevent overflowing. The side forms should not be tight against the plate but should be erected a minimum of 25 mm and a maximum of 100 mm from the edge base, rail or sole plate being grouted so that air being displaced is not trapped below the plate. Excessive edges create thermal stress and can result in cracking.

A 50 - 75mm clearance is recommended at the area where the grout is to be placed. The vertical form on the exit side (opposite the placing side) should be extended 50 – 100 mm away from the plate so that straps or other placing aids can be inserted to assist movement of the grout should that become necessary. Large non-supporting grout areas should be eliminated wherever possible.

TYPICAL HEADER BOX



The form on the placing side can be constructed to extend 50 –100 mm horizontally from the plate at the foundation, slanted upward at an approximate 45° angle to facilitate placement. A back board, or splash board form should be built on top of the plate and at the plate edge, opposite the slanted headboard, to prevent spillage of grout and provide containment of the “head” of grout as it is being placed. This will allow grout to be placed with a minimum of turbulence (and entrapment of air bubbles) while directing it smoothly under the plate. The further the grout must travel horizontally, the higher the slanted head box should be for a given consistency. This is to provide “head” pressure to direct the grout around shims, leveling screws, bolts, keys and other obstructions, to the exit side.

Alternatively, moderately sized equipment such as turbines and generators, or other base plates of lengthy dimensions, may utilize a portable “head box” which can be moved along the length of the plate as the grouting proceeds. This portable head box is a way to facilitate continuous flow of the grout and minimize forming costs. The box should utilize a head form sloped at 45 degrees that rests in part of the form, floor and/ or baseplate. This method serves just as well, and often better than a long-sloped form, as the thrust of the grout flow is better controlled.

Edge Chamfers

Eliminating sharp corners in the grout reduces stress concentration.

For Epoxy grouts, the chamfers can't be trimmed easily (Grinding is an option). Therefore, the chamfered edges need to be built into the forms, by 1 – 2 inches (25 – 50 mm) using chamfer strips on the forms. (See Section, *Causes and Prevention of Edge lifting in Epoxy Grouts* later in this grout manual for further explanation).

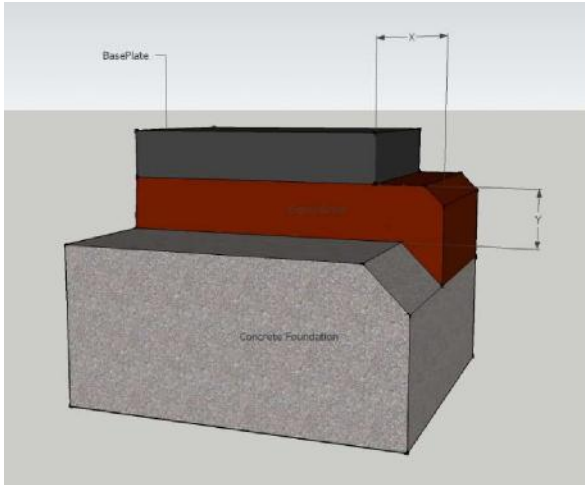

Shoulders of epoxy grouted equipment should be kept as small as practically possible and ideally their width (X) should always be less than their thickness (Y)

Deep Pour Recommendations – Reinforcing Bar Installation for MasterFlow 648 Epoxy Grout

The use of reinforcement bars is recommended where the total thickness of the **MasterFlow 648** grout is greater than 150 mm to minimize cracking and help draw excessive heat down into the base slab and transfer stress if cracks do occur.

The top tier should be located about 50 mm below the equipment base. A bottom tier should be located about 50 mm above the foundation surface. Additional tiers, if required, should be spaced equal distances in the grout pour with vertical supports as required.

A typical rebar layout is shown in Figure 1. Most rebar should run lengthwise in the grout with cross bars and vertical dowels placed at approximately 300 – 600 mm intervals as shown in Figure 1. Rows of rebar should be between 150 – 300 mm apart. Grout pours of ± 150 mm would require only one layer of horizontal rebar. Pours of >250 mm can benefit from an extra layer as shown in Figure 2.

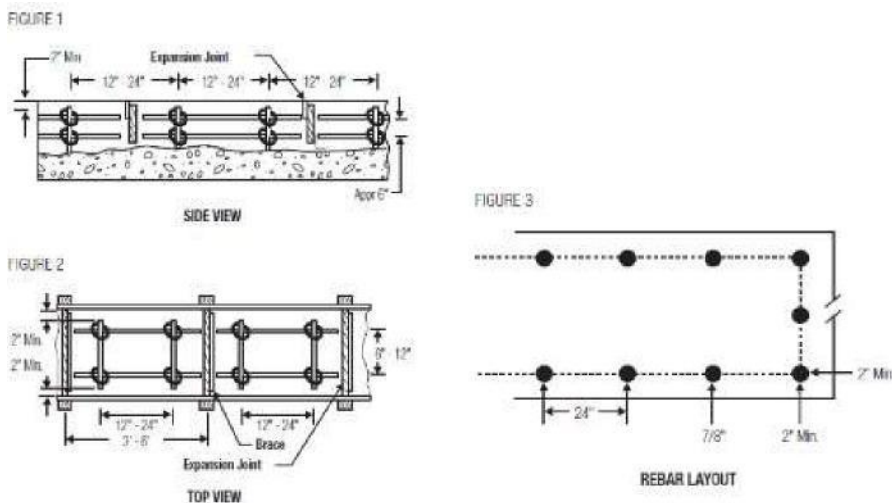

The horizontal rebar should be wired to vertical dowels that are grouted into the concrete base as shown in Figure 2. The horizontal and vertical bars are recommended to be constructed of $\text{Ø}13$ mm rebar and should be embedded to a depth of at least 150 mm in the concrete. The bars should be grouted with a specially formulated rebar anchor grout such as **MasterFlow 932 AN**. None of the rebar should be closer than 50 mm

to the nearest grout surface (Figure 3).

All rust, dirt and grease should be removed from the rebar prior to installation. Grit blasting will provide best adhesion (if allowed)

Epoxy grouts can also be placed in lifts. Silica sand is broadcast onto the first lift to provide an intermediate bondable surface, and the subsequent lift can proceed after about 24 hours when the first lift has hardened and cooled to the ambient temperature.

Epoxy Grout Application Thickness (in a single lift)

» MasterFlow 400	–	25mm up to 100mm
» MasterFlow 648 Fluid	–	50mm up to 150mm
» MasterFlow 648 Flowable	–	100mm up to 300mm

These are recommended maximum thicknesses applied in a single lift and are to a certain degree determined by ambient temperatures at the time of mixing and placing.

Mixing of Epoxy Grouts

Tools

1. Clean and dry 20 Litre metal or heavy duty plastic buckets
 2. Plenty of rags for wiping hands and tools.
 3. A supply of citrus degreaser or solvent for cleaning hands and tools
 4. Rubber Gloves and all other appropriate PPE.
- Optional. MasterFlow 648 can be cleaned with soap and water.

Grout Handling

1. Aggregate must be completely dry. It should be stored under cover and on pallets.
2. In cold weather, store all the components in a warm place for at least 24 hours; 20-25°C is preferred.
3. In hot weather, store in an air-conditioned container for at least 48 hours prior to being needed.

Mixing

Do not add solvent, water or any other material to the grout. Do not alter the Part A to Part B resin proportions – Mix ONLY full kits.

Mix the grout as close as practically possible to the area that it is needed – transportation of mixed epoxy grout over long distances in high ambient temperatures should be avoided.

1. Pour the hardener (Part B) into a 20 Litre bucket along with the Part A resin and mix slowly using a suitable heavy-duty mixer and mixing spiral for no more than 30 seconds until well mixed to a uniform amber color. DO NOT OVERMIX as this will entrap air bubbles within the fully mixed grout.
2. Add the aggregate whilst the mixer is running and mix only until aggregate is completely wetted out to avoid air entrapment. Scrape down the sides of the mixing vessel to ensure all aggregate is thoroughly combined. Mixing should take no more than 3 minutes.
3. Remove mixer and pour the grout directly from the mixing bucket.

Note: always add aggregate to the mixer after the premixed liquids have been poured in.

The temperature of the grout, foundation, and equipment base are more important than the air temperature because they will affect the grout flow rate. The required flow is related to the grout thickness (between the foundation and base) and the flow distance.

Placement of Epoxy Grout

1. 1. Pour the grout into the shuttering within 15 minutes of it being mixed. Any delay in pouring may affect the workability of the epoxy grout if left in the bucket (heat generation due to large volume / small surface area).

Epoxy Grouting

2. For flat bottom plates and bases, pour the grout from one side through to the other and always across the shortest distance.
3. When grouting closed areas, prevent air entrapment by starting at one end of the form and filling the cavity completely while advancing toward the other end.
4. **MasterFlow Epoxy Grouts** are flowable, but it can be aided with pushing tools like banding straps or plywood strips. Push with long, slow strokes rather than short jabs until no air pockets remain under the frames. **DO NOT VIBRATE.**
5. Where grout cannot be adequately worked to fill the cavity (because of large size or limited space), a head box will greatly assist flow. Use a sturdy wooden box (as described earlier, or sheet metal funnel about 300 - 600mm in length.
6. Check frequently for leaks in the form. Leaks do not self-seal. If not stopped, they will cause voids.
7. After the pour is complete, remove uncured epoxy from the mixer and tools with soap and water (**MasterFlow 648**) or a citrus degreaser. Cured material must be removed mechanically. A smooth finish on the grout shoulder may be obtained by brushing the surface with solvent. Best results can be obtained by smoothing the surface several times just prior to the hardening of the grout surface.
8. If a multi-pour installation is necessary (**MasterFlow 648 ONLY**), sprinkle a small amount of **MasterFlow 648** aggregate on the first pour's surface as the grout solidifies. Before placement of the second pour, brush / blow the loose aggregate from the first pour's surface.

Hot Weather Grouting

Avoid high temperatures while grouting. If the packaged grout is above 30°C, chill the sealed containers of grout resin (A & B) in a tub of ice, or cover the containers with water-soaked burlap/ hessian. When grouting under hot conditions ensure to cool the grout components and aggregate to below 25°C for minimum 48 hours before use.

Provide shade from summer sunlight for at least 24 hours before and 48 hours after grouting.



Cold Weather Grouting

Temperatures below 15°C make the grout stiff and hard to handle; the time required for set and strength gain is significantly increased. Do not use at ambient temperatures of less than 15°C unless artificial means of heating can be used to assist cure.

It is important that the grout components be transported and stored to prevent freezing. Prior to grouting in cold weather, Containers of the grout resin should be warmed to between 21°C and 30°C. Consider using **MasterFlow 400** or **Master Flow 648 Fluid** rather than **MasterFlow 648 Flowable**.

An enclosure should be erected around the equipment and foundation to be grouted (typical materials are polyethylene or canvas). Forced air or infrared heaters may be used to provide the necessary heat to increase the base plate and foundation temperatures above 10°C. Condition the grout mixing and transportation equipment also by placing it inside the enclosure prior to grouting, and be mindful of the speed of temperature change when discontinuing the heat source. Too fast will cause cracks and possibly damage the foundation.



A final important note: The molds and equipment used for testing the grout on site must be conditioned to the appropriate temperature just like the foundation and equipment, and kept at a stable temperature as per ASTM C 579 while in the field and in the lab prior to testing. And the molds must be allowed to reach initial set before transport to the lab.

Ideally the test “cubes” should be allowed to cure next to the equipment that has been grouted. In this way the results obtained would be a true reflection of what is under the equipment and NOT necessarily the same as results obtained in a temperature-controlled laboratory.

Pumping MasterFlow 400 and 648

Ensure material is conditioned by storing at ambient temperatures up to 25°C for a minimum of 48 hours before use.

Proper equipment is critical to successful pumping of epoxy grouts. Peristaltic and piston pumps are recommended.

Grout should be pumped through the shortest distance possible. The maximum distance should be limited to 15m. For pumping distances greater than 3 m, a 38 - 50mm diameter, PVC pipe should be used to convey grout from the pump outlet to the base of the equipment being grouted. A flexible, seamless, clear vinyl hose should be attached to the end of the PVC pipe to manipulate the grout into the grouting holes or around the forms.

Prime the pump and pump lines with the neat epoxy resin or vegetable oil before using and after each cleaning or hose replacement. Never prime the pump and hose with water or any other material that can contaminate the epoxy grout. Purge the pump, pipe and hose of all priming material prior to pumping the grout.

High flow mixes (**MasterFlow 400 / MasterFlow 648 Fluid**) are easier to pump than **MasterFlow 648 - Flowable**. Jobsite and weather conditions will influence the ability of the grout to be pumped successfully.

Once the grouting operation begins do not allow the pump to run out of material until the piece of equipment is completely grouted. Install the tip of the pump line through the grout holes in the equipment or between the formwork and the baseplate. Try to keep the tip of the grout line in sight whenever possible. Keep the pump line submerged in the grout and slowly withdraw it as the grout fills up under the application area. Avoid creating air pockets at all times.

As the grout fills the space beneath the baseplate, and can be seen at the next grout hole or at the edge of the formwork on the opposite side, move the pump line to the next grout hole or down the length of the form and continue pumping.

The pump and hose should be cleaned every 1-1/2 to 2 hours. If cleaned more frequently, soap and water will be effective; otherwise, a citrus degreaser should be used and followed with a final flush using vegetable oil. When the installation is complete, immediately clean the pump and lines.

Contact the pump equipment manufacturer for additional information on the use and operation of their pumps.

Curing of Epoxy Grout

Epoxy grouts develop high compressive strengths in as little as 12 hours and develop nearly 100% of their ultimate strength in seven days. See individual product data sheets for specific curing rates.

Curing rates are retarded at lower temperature and can be accelerated in many cases through the addition of an accelerator designed for use with the particular grout. See individual accelerator data sheets or contact a local Master Builders Solutions representative.

For most epoxy grouts, curing will not occur below 4°C.

Anchor Bolt Grouting

1. Bolts must be deformed bar, threaded rod, with nut or head preferred.
2. Bolts must be free of oil, grease and rust. Solvent wipe before placement with thinner. Grit blasting or abrasive wheel cleaning may be required.
3. **Holes** drilled dry must have dust blown out and be free of oil and grease. Wet drilled holes must have free water rinse to remove drilling slurry and then be force dried (oil-free compressed air or similar). Formed holes must be chipped to remove laitance and form oil residue. If polystyrene was used for forms, do not melt with petrol or thinner because a sticky residue will remain. Mechanically remove polystyrene and clean hole with wire brush or scraper on a vibrating hammer.

Typical Hole Dimension Requirements – These are only a guide and the exact details of Bolt Hole requirements MUST be provided by the equipment supplier or Resident Engineer responsible for the foundation design.

Depth = 12 times bolt diameter. Diameter = 1.5 times bolt diameter.

Anchor bolt depths greater than 600 mm deep, a minimum bolt diameter of greater than 2 inches (50 mm) is recommended.

Cracking

Epoxy-based grouts will sometimes develop cracks. Cracking is generally caused by thermal stresses and temperature differences from season to season, as well as operating to non- operating temperatures.

Cracking can occur on the shoulder surface near sharp corners of the baseplate due to lack of restraint at that point and at anchor bolts. Horizontal edge cracks may occur just below the grout-concrete interface, most often in outdoor installations, due to the differential thermal movement, and the crack is typically limited to the unrestrained shoulder area.

In most cases cracking does not impact the support and alignment performance of the grout. If there is concern regarding the likelihood of cracks allowing oil or chemical contamination of the concrete substrate, the cracks should be filled with an epoxy grout (resins only) or other epoxy-based material.

Contact your local Master Builders Solutions representative for recommendations.

The likelihood of cracking can be significantly reduced by:

- » proper foundation preparation, correct form geometry, chamfering edges of foundation and grout
- » Installation of reinforcement and expansion joints.
- » Controlling the rate of heat generation and proper installation procedures.

All of which are discussed in this manual.

Expansion Joints

The Need for Expansion Joints

In order to maintain alignment of grouted equipment, epoxy machinery grouts are designed to be rigid and have high resistance to creep. By their composition, epoxy grouts have a dissimilar coefficient of thermal expansion compared to concrete. As a result, stresses that occur during cure and subsequent temperature changes may result in cracks.

Grout cracks do not directly affect the ability of the grout to support the equipment, but they do provide an entrance point for oils and other contaminants that can eventually lead to problems in the foundation. Expansion joints should be used when the span of the grout exceeds ± 1.5 m in any direction to prevent excessive stresses on the grout / concrete interface from building up, which can cause cracking, edge lifting etc.

Location and Design of Expansion Joints

It is normally recommended that expansion joints be located at 0.9 – 1.8 m intervals along the length of the “shoulders”. More expansion joints may be needed if the grout will experience a temperature drop of more than 4°C below the installation temperature. Joints should be placed so as not to interfere with sole plates, chocks or anchor bolts. For best results, they should be spaced evenly between anchor bolts or sole plates. There are a variety of techniques for preparing expansion joints in epoxy grout. Different joint designs are appropriate for different types of installations. Two basic types of joints are discussed below.

Standard Single Seal Expansion Joint

Grooves must be placed in the grout for this design. It is preferable to create the groove with the formwork. Dividers are placed in the form where the joints are to be located. The dividers consist of an interior portion of 19 mm wood or fiberboard expansion joint material and an outer removable portion consisting of 19 mm wood covered with polyethylene or duct tape to prevent bonding. The outer removable portion should extend above the finished grout to facilitate removal. The removable portion of the divider should be sized to provide a finished groove in the grout that is approximately 19 mm wide and 38 mm deep.

When the grout is sufficiently hardened, the exterior portions of the dividers are removed. A standard 25 mm foam polyethylene backer rod is forced into the bottom of the groove and the rest of the groove is filled with a good quality joint sealant. The surface of the expansion joint material can be tooled to a neat concave or flat surface as shown in Figure 1.

Composite Joints Containing Both a Primary and a Secondary Seal

FIGURE 1

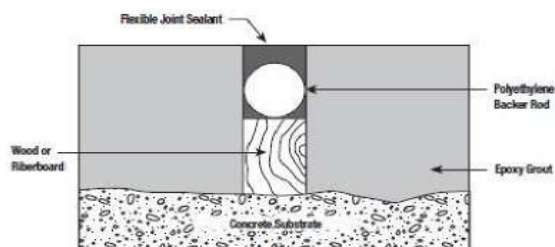

A composite joint that contains an interior timber portion and an exterior portion of closed cell foam (See Figures 2, 2A) provides double protection against oil intrusion. The timber interior is set in place using an epoxy mortar that acts as a secondary seal to prevent oil and other fluids from penetrating the concrete. The grout bonds to the closed cell foam forming a tight primary seal against oil penetration.

FIGURE 2

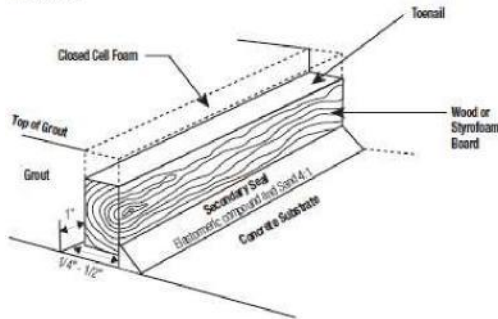
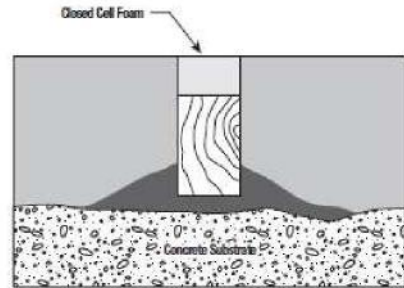

FIGURE 2A



The wooden portion of the joint should be made from standard finished soft timber that has a nominal thickness of $\pm 20\text{mm}$.

The wood is installed after the concrete surface has been chipped and the forms have been built. A mixture of one-part expansion joint sealant (**MasterSeal NP 472**) and four parts dry silica sand (**MasterTop SR 3**) is used to prepare a flexible mortar for the secondary seal. This material is applied to the concrete in strips about 2–3 inches (51–76 mm) wide by 1 inch (25 mm) deep, running the entire length of the joint. The timber strip should be immediately embedded to a depth of about 1/2–3/4 inch (13–19 mm).

The lumber should be smaller than the completed joint by 1 inch (25 mm) to allow for attachment of a primary seal consisting of 1 inch by 1 inch (25 by 25 mm) chemical resistant closed cell foam (see Figure 2). The closed cell foam may be attached to the wooden portion of the expansion joint in one of several ways.

1. Glue the foam to the wood using epoxy adhesive (**MasterBrace ADH 2200**)
2. Glue the foam to the wood using **MasterWeld 303 / MasterWeld 909**
3. Nail the foam to the wood by toenailing from the side (Figure 2).

CAUTION: Do not drive nails through the top of the foam as this destroys the foam's sealing ability.

If the foam has a tough skin on one side, this portion of the foam should be faced outward. The vertical face of the expansion joint should be sealed also. This can be done by extending the foam down the vertical face as shown in Figure 3. If a notch is cut into the foam as shown in Figure 4, it aids in the foam's conforming to the bend in the expansion joint.

FIGURE 3

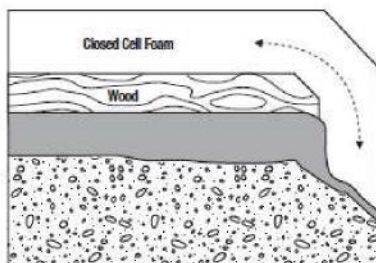

FIGURE 4



For shallow pours of 25–50mm, the wooden portion of the joint can be eliminated. Closed cell

foam with notches to conform to vertical sides (see Figure 3) should be bonded directly to the concrete with or without a secondary seal.

A variation of the above design is to use an epoxy joint sealant as the external joint. Using this method, the wood joint is initially brought up to the surface of the finished grout. After the grout is then placed and cured, the wood is removed to a depth of 1/4–1/2 inch

(6–13 mm) below the grout surface. The typical width of the joint is twice the depth (see Figure 5).

Causes and Prevention of Edge lifting in Epoxy Grouts

Edge lifting is a term generally used to refer to horizontal cracks around the edges and corners of grouted foundations (see Figure below). The crack starts on the vertical concrete surface just below the grout / concrete interface and may extend back under the grout from 50–150mm. This cracking is usually accompanied by slight upward movement at the edge. This movement is called “edge lifting” or “curling.”

FIGURE 5

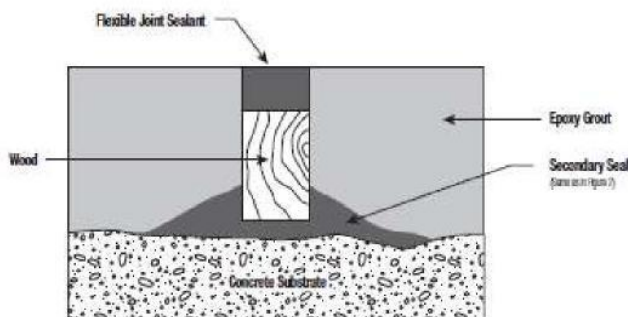

The initial cracking occurs when the shear stress near the concrete / grout interface exceeds the strength of the concrete. The shear stresses are a result of a combination of factors.

When the grout cures there is a certain level of trapped stress caused by the combination of the curing shrinkage and the exotherm of the grout. Additional stresses occur as the grout and foundation undergo thermal cycling. Stresses created during thermal cycling are caused by uneven heating and cooling in various parts of the structure and by differences between the coefficient of thermal expansion of the grout and the concrete.

FIGURE 1

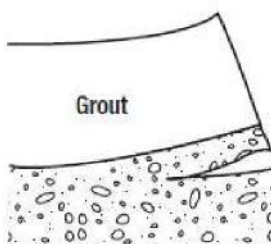

The potential for edge lifting / curling is increased by these factors:

1. High maximum curing temperatures increase the stress that causes edge lifting. Conditions contributing to high maximum curing temperatures include: pouring large amounts of grout in one pour, placing the grout at high ambient temperatures without taking precautions to reduce the exotherm or using an epoxy grout that is not designed for large pours.
2. Large temperature swings will increase the tendency to edge lift by increasing the effects of the differential coefficient of expansion. In cold weather the grout will tend to curl up as it tries to shrink more than the concrete.
3. Wide overpours and long grout lengths have a greater tendency to edge lift. (Shoulder width greater than thickness)
4. Low concrete strength or inadequate surface preparation increases the tendency to edge lift since the poor-quality concrete will fail at lower stress levels than good quality concrete.
5. Grout that has been placed with less than the manufacturer's specified amount of aggregate has an increased tendency to edge lift. There are two reasons for this tendency.

First, the exotherm of the grout will be higher than intended, and second, the coefficient of thermal expansion will be higher than expected.

The following precautions can be taken to minimize edge lifting:

1. The concrete surface should be prepared by chipping down to sound concrete with a compressive strength >25MPa. Loose and broken pieces must be removed. The surface should be dry and dust-free before the grout is poured.
2. Where possible, the edges of the concrete foundation should be chamfered at least 50 – 100 mm) at approximately a 45° angle.
3. The overpour should be reduced to a practical minimum. When large overpours cannot be eliminated it may be necessary to install reinforcement to prevent the shoulders curling – see below.
4. A basic rule of thumb applies to shoulder width the grout thickness – width of any un-restrained “shoulder” should be less than the grouts thickness and it may still be wise to install additional rebar anchors – depending upon shoulder lengths and temperature

variations between night and day etc.

1. Eliminate sharp corners in the grout to reduce stress concentration at the corners. Chamfer the edge of the grout corners by 25–50 mm using chamfer strips on the forms.
2. Do not deviate from the manufacturer’s specifications for placement temperature limits.

Procedures for using dowels or wickets to prevent edge lifting / curling:

1. Dowels should be preplaced at strategic locations around the base of the concrete as shown in Figure 2. The dowels are similar to the vertical reinforcing steel described earlier and are installed in the same way.
2. Wickets provide the strongest anchor between the grout and the concrete base. They are made from U-shaped pieces of rod or rebar and are installed as shown in Figure 3. If wickets are not used, dowels should be utilized instead.

Compressive Strength & Compressive Strength Testing

Compressive strength is a measure of the maximum load the grout can withstand before failure. Since the purpose of a grout is to transfer loads from the equipment to the concrete foundation, it makes sense that the grout compressive strength is greater than the base, and able to accept the load demands of the machinery being supported. Compressive strength alone doesn't guarantee satisfactory performance, but it is critical, and an important indicator for other performance parameters.

FIGURE 2

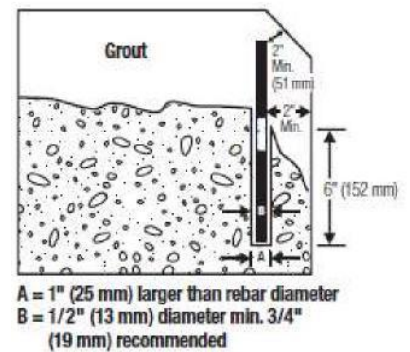
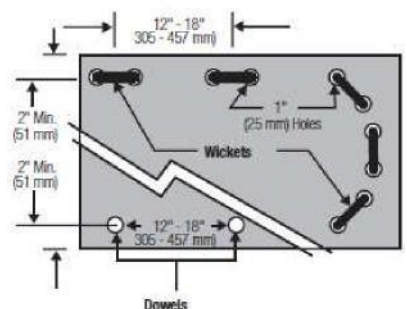
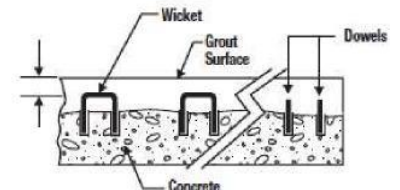
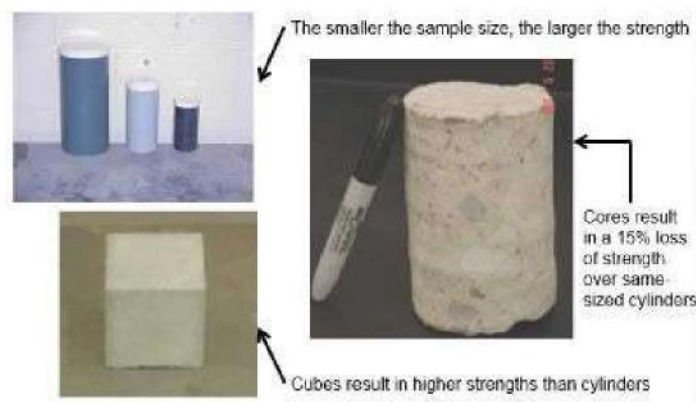

FIGURE 3



There are many ways to test for a material's compressive strength.

Different test methods and protocols yield different results, so it is equally important that the design documents specify the test method and provide clarity and instruction on the procedure for taking samples in the field.



The correct ASTM test method for determining compressive strength of **polymer grouts** is ASTM C579. Method B of this standard, which calls for casting and testing 50mm CUBES, provides more accurate values, as opposed to other methods which use cylinder samples. This is similar to the ASTM C1107 testing protocol used for cementitious grouts and mortars.

Preparing Epoxy Grout Samples in the Field for ASTM C579 Testing

Ensure proper cube molds are used

- » Use metal / brass cube molds, with 2" (50 mm) sides.
- » NEVER USE PLASITIC INSERTS!!



- » Seal the edges with wax. Apply mold release
- » Place on a flat, level surface, where they can remain undisturbed until set.
- » The molds must be conditioned to temperature just like the foundation and equipment.

Mix Grout

Care must be taken to ensure proper mixing. Ensure correct temperatures of grout components, mixing and transportation tools, and testing apparatus (molds, etc.). Never pull material from the first mixing batch and the sample should be taken from the middle of the grout mass.

Fill the Molds

- » Fill molds halfway, then consolidate grout per ASTM C109 using a tamper and pattern.

Fill molds to top and consolidate again Strike off excess grout and level the surface.



The filled molds must be kept warm as per as per ASTM C 579 while in the field and in the lab prior to testing.

This is a key difference between cementitious and epoxy grout testing. Cementitious grouts are usually fluid or flowable. They need very little compaction so a light poking with a finger or tamper is all that's needed to ensure that there's no air trapped in the corners of the mold. Only stiff (or plastic) grouts need to be tamped 16 times per layer following the ASTM pattern.

Curing

After striking off the excess grout from the mold, leave the material undisturbed for a minimum of 24 hours. Make sure it is in a temperature-controlled location away from vibrating equipment. Alternatively, If the cubes are being used to determine in-situ strength gain, then the molds should be left on site, next to the installation.

Epoxy grout samples should only be air cured and do not require any form of restraint.

The molds must be allowed to reach initial set before transporting them.

This is another difference in testing epoxy grouts. When preparing samples for cementitious grouts, the grout cubes must be restrained, so the molds are stacked, and/or a plate is firmly clamped on top and then they are sealed in plastic bag and/or wrapped in to create a moist, temperature controlled curing environment.

Conclusion

Master Builders Solutions offers advanced chemical solutions for new construction, maintenance, repair or renovation of structures and infrastructure. The Master Builders Solutions brand builds on the strengths of many legacy products and represents our experience of more than 100 years in the construction industry.

Being part of the largest chemical company in the world has many advantages. Key among them is the ability to serve our customers wherever their projects take them. Our world is becoming increasingly connected, and in many industry sectors global owners, engineers and contractors work across continents, countries and cultures on new construction and refurbishment projects. Traditional boundaries have been removed.

At Master Builders Solutions, we are uniquely positioned to supply and service these projects, because with this increased globalization comes the need for consistency in the products that are specified and installed.

Across the globe, engineers, equipment manufacturers, contractors and owners can confidently specify and install MasterFlow grout products with confidence. Master Builders Solutions teams on every continent provide reliable, dependable product availability and technical support.

Learn more about Master Builders Solutions MasterFlow Epoxy Grouts here:

<https://www.master-builders-solutions.com/en-ae/products/masterflow>



Master Builders Solutions for the Construction Industry

MasterAir®

Complete solutions for air entrained concrete

MasterBrace®

Solutions for concrete strengthening

MasterCast®

Solutions for the manufactured concrete product industry

MasterCem®

Solutions for cement manufacture

MasterEase®

Solutions for reducing concrete viscosity

MasterEmaco®

Solutions for concrete repair

MasterFinish®

Solutions for formwork treatment

MasterFlame®

Complete firestopping solutions

MasterFlow®

Solutions for precision grouting

MasterFiber®

Comprehensive solutions for fiber reinforced concrete

MasterGlenium®

Solutions for hyperplasticized concrete

MasterInject®

Solutions for concrete injection

MasterKure®

Solutions for concrete curing

MasterLife®

Solutions for enhanced durability

MasterMatrix®

Advanced rheology control solutions for self-consolidating concrete

MasterPel®

Solutions for water tight concrete

MasterPolyheed®

Solutions for mid-range concrete

MasterPozzolith®

Solutions for water-reduced concrete

MasterProtect®

Solutions for concrete protection

MasterRheobuild®

Solutions for high strength concrete

MasterRoc®

Solutions for underground construction

MasterSeal®

Solutions for waterproofing and sealing

MasterSet®

Solutions for set control

MasterTile®

Solutions for tile fixing system

MasterTop®

Solutions for industrial and commercial floors

MasterWeld®

Adhesive solutions for construction

Master X-Seed®

Advance addelerator solutions for concrete

Ucrete®

Flooring solutions for harsh environments

Contact Information:

Head Office

Al-Othman Business Tower 14th Floor, King Saud Road, Al Qashlah, Dhahran 34232, P.O. Box 1884, Al Khobar 31952
 Tel: +96613 8538600, 13812 1140
 Fax : +966 13 832 8671, 13 812 1822

Riyadh Sales Office

Tel.:+966 11 2790971 / 72
 Fax : +966 11 279 0970

Registered Office / Factory

P.O. Box 1884 Al-Khobar 31952 , Road No. 58, Hail Street , 2nd Industrial City, Dammam, KSA
 Tel.:+966 13 812 1140
 Fax:+966138121822

Jeddah Sales Office

Tel: +966 12 639 4799
 12 639 5702
 Fax : +966 12 639 4934

